

Clarke®

air



Air Compressor

Models: CFP9HND

Part Number: 2090901

Operating & Maintenance Instructions



WARNING!

**DO NOT ATTEMPT TO ALTER ENGINE SPEED SETTINGS
DOING SO WILL INVALIDATE YOUR GUARANTEE**

SPECIFICATIONS

	CFP9ND
Part Number	2090901
Engine Type	HONDA
Pump Type	MK238
Air Receiver size	2.65 litres
Max. output Pressure	100psi
Air Displacement	9cfm
Outlet connectors	1/4" BSP
Dimensions (mm)	520x360x440
Weight (kg)	21
Guarenteed Sound Power Level	96.5dB _{WA}

NOTE:

Specifications are correct at the time of going to print.
Clarke International reserves the right to change specifications at any time, as it sees fit, in the interests of safety or improvement in design.

Read these safety instructions before using the equipment.

INTRODUCTION

Thank you for purchasing this Clarke Air portable compressor. The unit is powered by a 5HP Honda engine, a manual for which, is provided separately. Please refer to that manual for all matters relating to the engine, ...starting and stopping procedures, maintenance etc.

GUARANTEE

This product is guaranteed against faults in manufacture for 12 months from purchase date. Please keep your receipt as proof of purchase.

This guarantee is invalid if the product has been abused or tampered with in any way, or not used for the purpose for which it is intended.

The reason for return must be clearly stated.

This guarantee does not affect your statutory rights.

CONTENTS

Page

Introduction	4
Guarantee	4
For your Own Safety	5
Important General Notes	6
General Layout	7
Preparation for Use	8
Starting & Using your Air Compressor	9
Shutting Down the Compressor	10
Maintenance	11
Troubleshooting	12
Parts and Service Contacts	14
Parts Lists and Diagrams	15-17
Declaration of Conformity	18

FOR YOUR SAFETY

WARNING

*As with all machinery, there are certain hazards involved with their operation and use. Exercising respect and caution will considerably lessen the risk of personal injury. However, if normal safety precautions are overlooked, or ignored, personal injury to the operator, or damage to property may result.
It is in your own interest to read and pay attention to the following rules:*

General Precautions

ALWAYS

- ensure that all individuals using the compressor have read and fully understand the Operating Instructions supplied.
- Stop the engine and ensure the pressure is expelled from the air receiver **BEFORE** carrying out any maintenance.
- ensure that there is adequate ventilation when spraying flammable materials e.g. cellulose paint, and keep clear of any possible source of ignition.
- protect yourself. Think carefully about any potential hazards which may be created by using the air compressor and use the appropriate protection. e.g. Goggles will protect your eyes from flying particles. Face masks will protect you against paint spray and/or fumes. Ear defenders will prevent hearing damage caused by loud noise.
- consult paint manufacturers instructions for safety and usage, before spraying
- ensure that the air supply is turned off at the machine outlet and all pressurised air from the machine and other equipment attached to it, is expelled **BEFORE** disconnecting air hoses or other equipment.
- make sure that children and animals are kept well away from the compressor and any equipment attached to it.
- ensure that any equipment or tool used in conjunction with your compressor, has a safety working pressure exceeding that of the machine.

NEVER

- direct a jet of air at people or animals, and **NEVER** discharge compressed air against the skin. **COMPRESSED AIR CAN BE DANGEROUS!**
- leave pressure in the receiver overnight, or when transporting.
- adjust, or tamper with the safety valves. The maximum pressure is factory set, and clearly marked on the machine.
- operate in wet or damp conditions. Keep the machine dry at all times. Similarly, a clean atmosphere will ensure efficient operation. Do not use in dusty or otherwise dirty locations.
- touch the machine until it has cooled down...some of the metal parts can become quite hot during operation.
- operate your compressor with any guards removed.

Fire Prevention

ALWAYS

- switch the engine OFF when refuelling.
- refuel away from any source of heat.
- refuel in a well ventilated area.



NEVER

- overfill the tank, fill to the level specified.
- smoke whilst refuelling and avoid smoking or using a naked flame near the compressor.
- start the engine if there is spilled fuel. Any spillage must be wiped clean and the compressor allowed to dry before attempting to start the engine.

Exhaust Gas Precautions

ALWAYS

- ensure there is adequate ventilation when using the compressor.
- position the compressor so that the exhaust is pointed away from people or animals.

NEVER

WARNING:

Exhaust fumes can be fatal

- Do not use the compressor indoors or in an enclosed area. (i.e. in a warehouse, tunnel, well, hold etc.)

IMPORTANT General Notes

- **NEVER allow anyone, not fully familiar with compressors, to use this equipment.**
- **DO NOT alter the engine settings....these settings are set at the factory. Should they need recalibration - consult your Clarke dealer**

GENERAL LAYOUT

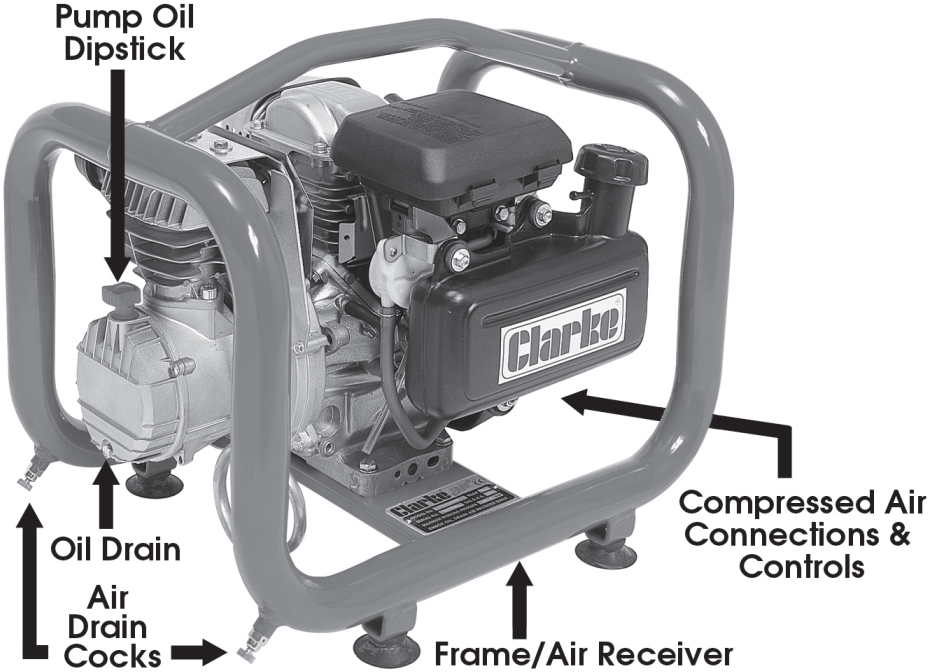

CFP9ND

Fig.1

PREPARATION FOR USE

The engine and compressor are supplied without oil inside, a small bottle is provided in the box and must be added before use (approx 0.6l to the engine and 0.4l to the pump).

A. Environmental

- Ensure the compressor is sited on a firm level surface.
- Ensure the environment is dry and dust free.
- Ensure there is adequate ventilation for:
 - a) Air intake to compressor pump
 - b) Cooling for compressor pump
 - c) Engine exhaust gases.

B. Engine

- Perform a visual check of components and check oil and fuel levels .
Refer to engine service manual.

C. Pump

- Check oil level on the Dipstick - to level marked.

D. Fueling



Fill with unleaded petrol, according to the instructions within the engine manual.

- Ensure the fuel tap is set to the required position.
- Ensure The fuel hose and connectors are intact, in perfectly servicable condition and there is no leakage.

Note : Always use a funnel to fill the fuel tank so as to avoid accidental spillage of fuel. If fuel is spilled it must be removed from the unit and surrounding area, before attempting to start the engine.

E. Receiver

- Drain off any condensate, by opening the drain cock (see Fig. 1). Remember to close the cock when completed.

NOTE: This should be carried out DAILY when the compressor is in constant use.

F. Air Hose & Air Tool

- Attach the air hose to the outlet using an appropriate connector.
- Attach the air tool/spray gun to the air hose...If using snap couplings, use a whip end, available from your Clarke dealer.

STARTING AND USING THE COMPRESSOR

First time startup

NOTE: For first time operation, do not connect the air hose or any tools and proceed as follows:

1. Start the engine, according to the instructions contained in the engine service manual, and allow to run for 10 minutes.
2. After a ten minute period, stop the engine and attach an air hose to the air outlet and the tool.
3. Screw the pressure regulator fully anticlockwise, then restart the engine and allow pressure to build up in the receiver.

Screw the pressure regulator clockwise until the pressure, registered on the Pressure Gauge, is 100psi.

At this point, check the system for air leaks. If any are apparent, stop the engine and operate the tool until the air pressure is at zero, or open the drain cocks before rectifying.

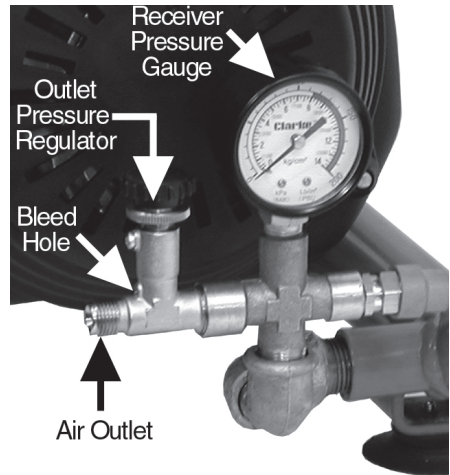

Fig.2

NOTE: Air will blow off at the bleed hole when the pressure reaches 100psi, which is the MAX. operating pressure.

4. With the engine running, turn the pressure regulator so that your desired pressure is registered on the gauge, and proceed to use the air tool in accordance with the manufacturers instructions.

When starting subsequently, start the machine as follows:

1. At the beginning of the day, open the drain cocks (see Fig.1) and allow any condensate to drain completely, then close the cocks.
2. Connect the air hose to the air outlet and tool, and set the pressure regulator to zero pressure (turned fully anticlockwise).
3. Start the engine in accordance with the instructions contained in the engine service manual, and allow pressure to build up.
4. When the pressure in the receiver has built up and air blows off at the bleed hole, turn the outlet pressure regulator clockwise so that the desired pressure is registered on the pressure gauge and proceed to use the air tool/spray gun.
5. Check for air leaks at the tool and connectors...as above, before proceeding.

STOPPING THE COMPRESSOR

At the end of the day, stop the engine in accordance with the instructions in the engine manual, then open the drain cock.

1. Turn the regulator fully anticlockwise.
2. Operate the air tool trigger or operating lever etc., to ensure there is no pressure in the air line, then disconnect airline and tool.

DO NOT under any circumstances attempt to remove the air tool or disconnect the air hose until you are satisfied that the pressure has been relieved.

3. Finally, close the drain cock.

Take care not to touch the engine or pump as they remain hot for some time after use.

REPLACEMENT OILS

Replacement oils are available from your Clarke dealer as follows:

1 litre of Compressor pump oil - Part No. 3050796

1 litre of Engine oil - Part No. 3050852

MAINTENANCE

DAILY

- a. Drain Air Receiver of any condensate
- b. Check engine oil level and top up where necessary. Ensure the dipstick breather hole is not blocked.
- c. Check pump oil level

WEEKLY

- a. Clean Pump Filter
 1. Turn Pump Filter cover and pull away to reveal paper element. If badly contaminated, replace. Remove any loose contaminants if any then replace.
- b. Clean the engine cooling fins.

6 MONTHLY

Renew pump lubricating oil, and

Fig.3

Make sure the cylinder head bolts are tight (see below)

Drain pump by removing the drain screw (Arrowed in Fig.3).

Replace screw and top up until oil is level with the mark on the dipstick, using compressor oil available from your Clarke dealer as follows: Part No. 3050796

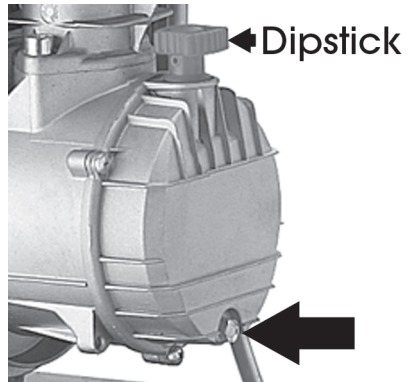

In addition to the above, check the engine manual for service schedule.

Repairs should only be carried out by a qualified engineer. If problems occur, contact your Clarke dealer.

Torque values for cylinder head bolts

MODEL NUMBER	Torque Vaule (NM)
CFP9ND	8.8 - 9.3

TROUBLE SHOOTING CHART

IMPORTANT

1. Any remedial work that may be required must be carried out by a qualified engineer.
2. Switch off the engine before removing any parts from the compressor.
3. Drain the Air Receiver before dismantling any part of the compressor unit's pressure system.
4. If your compressor develops a fault do not use until the fault has been rectified.
5. For troubleshooting the engine, refer to the engine manual.

SYMPTOM	PROBABLE CAUSE	REMEDY
Engine difficult to start	Load Genie leaking (compressor unit is on load during start). Load Genie valve blocked, possibly frozen up.	Stop engine and empty air receiver. Clean or replace Load Genie Thaw Load Genie out (Unit must be installed in frost-free place).
Compressor unit constantly 'on load'	Load Genie defective. Load Genie set at a pressure higher than the safety valve's opening pressure. Load Genie leaking.	Have Load Genie serviced or replaced Contact Clarke Service Department Contact Clarke Service Department
Compressor constantly 'on load' and cannot attain the working pressure required.	Suction filter blocked. Leak between compressor block and air receiver leaks in or near air receiver. Valves blocked by dirt, paint, dust or choked up. Inspection cover or drain plug leaking. Pressure gauge defective. Unit too small in relation to air consumption. Compressor worn.	Clean / Change filter. Tighten connection and repair leak. Contact Clarke Service Department Empty air receiver and change seals/plugs. Change pressure gauge. Use a larger capacity compressor Have compressor overhauled or replace it.

<p>Unusual noise from compressor.</p>	<p>Bolts loose. Flywheel loose. Unit installed on an unsuitable base. Bearings, piston rings or cylinder worn. Valve broken.</p>	<p>Tighten bolts. Tighten flywheel. Move unit to a more solid base. Contact Clarke Service Department Contact Clarke Service Department</p>
<p>Compressor becomes too hot.</p>	<p>Insufficient ventilation. Oil level too low (check 2 or 3 times after stopping). Fault in valves (machine not stopping). Blown head gasket (machine not stopping). Dirt on cooling fins or suction filter. Unit working at too high a pressure. Non-return valve partly blocked. Compressor being overworked and running continuously.</p>	<p>See that sufficient air is supplied to flywheel or fan of compressor and that hot air is properly vented. Fill with oil – see Page 10. Contact Clarke Service Department Contact Clarke Service Department Clean cooling fins and suction filter. Contact Clarke Service Department Clean or that out non return valve. Connect to a supplementary compressor or install a larger model.</p>

Compressor unit runs on and off load more frequently than usual.	Large amount of condensation in air receiver. Leaks in system	Drain off condensation Regularly (Every day before use). Locate leaks (by means of soapy water) and repair.
Compressor unit runs 'on load' when no air is being used.	Leaks in system.	Locate leaks (by means of soapy water) and repair.
Compressor's oil consumption rising.	Too much oil in compressor. Leaks around crank case. Working temperature of compressor too high because of insufficient cooling. Cylinder worn. Intake air filter blocked.	Check oil level 2 or 3 minutes after stopping. Contact Clarke Service Department Increase ventilation to air compressor. Contact Clarke Service Department Clean or replace
Oil in the air delivered.	Sump over full. Cylinder worn. Intake air filter blocked.	Reduce oil to correct level. Contact Clarke Service Department Clean / Change air filter.
Oil level rises although no oil has been put in.	Condensation in oil pump.	Compressor over dimensioned.
Condensation at outlet points.	Piping installation incorrect. Compressor taking in air which is too warm.	Consult your local dealer. Obtain better fresh-air supply to compressor.

For Spare Parts and Service, please contact your nearest dealer, or CLARKE International, on one of the following numbers.

PARTS & SERVICE TEL: 020 8988 7400

PARTS & SERVICE FAX: 020 8558 3622

or e-mail as follows:

PARTS: Parts@clarkeinternational.com

SERVICE: Service@clarkeinternational.com

PUMP PARTS

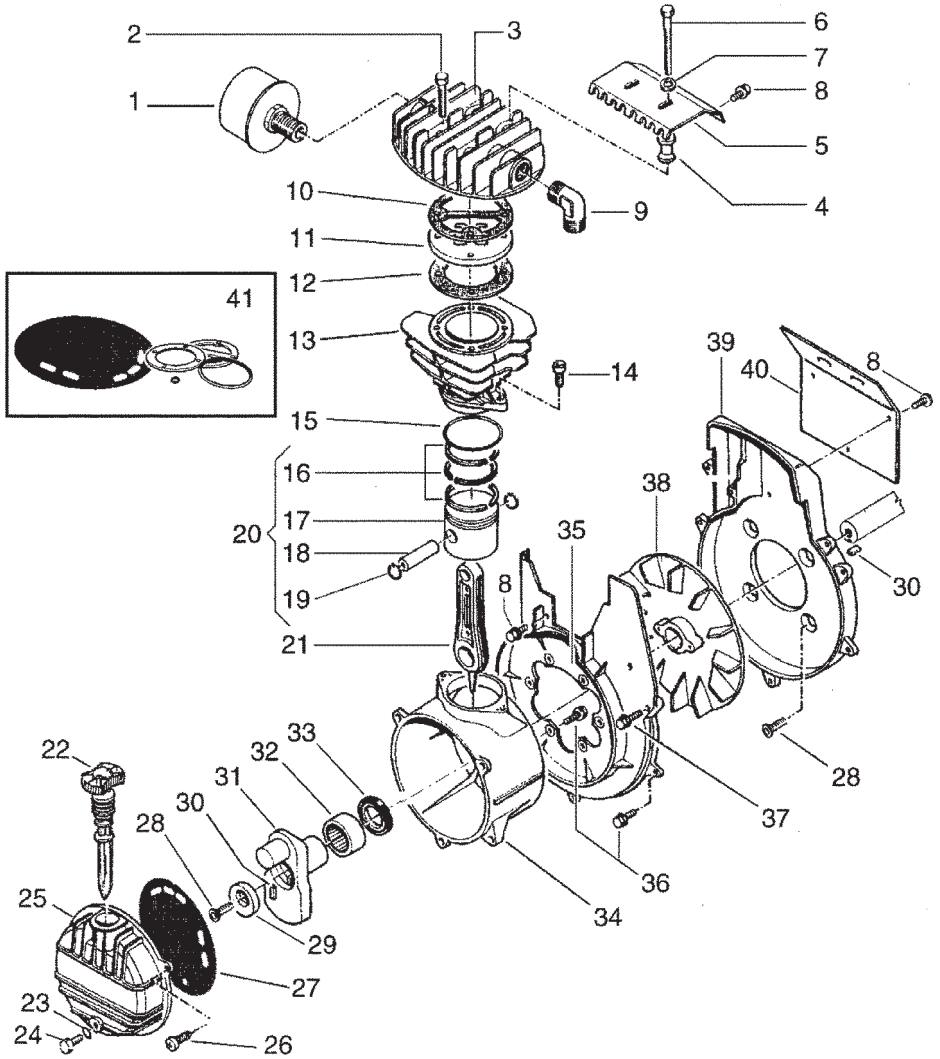

PUMP PARTS

No.	Description	Part No.
1	Air Filter Assy	FN317013000
2	Head Bolt M6x45	FN014002021
3	Cylinder Head	FN116001001
4	Spacer	FN116060015
5	Heat Shield	FN116060016
6	Screw M6x70	FN014002029
7	Washer 6.5x18	FN014005044
8	Screw M5x15	FN014013042
9	Elbow	FN011015000
10	Gasket	FN116022009
11	Valve plate	FN116022100
12	Gasket	FN116022010
13	Cylinder	FN116022001
14	Screw M8x20	FN014011064
15	O-Ring	FN010114000
16	Piston Ring Set	FN216022002
17	Piston	FN116022004
18	Gudgeon Pin	FN116022040
19	Circlip	FN015001000
20	Piston Complete	FN416022004
21	Con-Rod	FN116091021
22	Dipstick	FN012035000
23	Washer	FN010072000
24	Screw M6x10	FN014013024
25	End Casing	FN016032014
26	Screw	FN014006083
27	Gasket	FN116001025
28	Screw	FN014022001
29	Eccentric	FN116060005
30	Key	FN116060006
31	Crankshaft	FN116060001
32	Bearing	FN033058000
33	Seal	FN010060000
34	Crankcase	FN116060011
35	Casing	FN116060003
36	Screw M5x20	FN014013046
37	Screw M5x25	FN014013045
38	Fan	FN016060002
39	End Casing	FN116060004
40	Shield	FN116060010
41	Gasket Kit	FN216GA0001

PARTS LIST - ENGINE

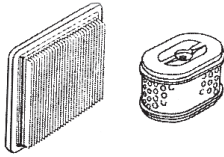

HS17211-ZL8-000

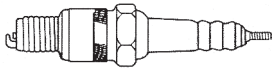

HS98079-56846

1.

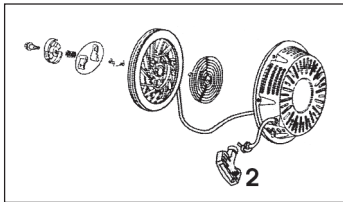

1. HS28400-ZL8-013ZA

2. HS28462-ZL8003

RECEIVER AND ANCILLIARY PARTS

No. Description	Part No.
	CFP9ND
1 Pump MK 238	1370005
2 Engine Honda 5HP	Contact Spares Department
4 Drain Cock	2000221
5 Bottom Entry Gauge	2000171
6 Safety Valve	2000192
7 Manifold 4-way	FN011276000
8 Rubber Foot	FN116011006
9 Regulator Assy	FN347026000
10 Back Entry Gauge	N/A
11 1/2" Load Genie	N/A
12 15mm Wheel	N/A
13 Wheel Retaining Clip	N/A
14 Rubber Foot	N/A
15 Mini Filter Regulator	N/A
16 Manifold 3-way	N/A



Clarke[®] INTERNATIONAL

Hemnall Street, Epping, Essex CM16 4LG

DECLARATION OF CONFORMITY

This is an important document and should be retained.

We hereby declare that this product(s) complies with the following directive(s):

2006/42/EC *Machinery Directive.*
2014/30/EU *Electromagnetic Compatibility Directive.*
2011/65/EU *Restriction of Hazardous substances.*

The following standards have been applied to the product(s):

*EN 60335-1:2012+A11:2014, EN 62233:2008, EN 1012-1:2010, EN 61000-3-2:2014,
EN 61000-3-3:2013.*

The technical documentation required to demonstrate that the product(s) meet(s) the requirement(s) of the aforementioned directive(s) has been compiled and is available for inspection by the relevant enforcement authorities.

The CE mark was first applied in: 2016

Product Description: Portable Frame Air Compressor.
Model number(s): CFP9HND.
Serial / batch Number: N/A.
Date of Issue: 08/12/2016.

Signed:

J.A. Clarke
Director

A SELECTION FROM THE VAST RANGE OF

Clarke®

QUALITY PRODUCTS

AIR COMPRESSORS

From DIY to industrial, Plus air tools, spray guns and accessories.

GENERATORS

Prime duty or emergency standby for business, home and leisure.

POWER WASHERS

Hot and cold, electric and engine driven - we have what you need

WELDERS

Mig, Arc, Tig and Spot. From DIY to auto/industrial.

METALWORKING

Drills, grinders and saws for DIY and professional use.

WOODWORKING

Saws, sanders, lathes, mortisers and dust extraction.

HYDRAULICS

Cranes, body repair kits, transmission jacks for all types of workshop use.

WATER PUMPS

Submersible, electric and engine driven for DIY, agriculture and industry.

POWERTOOLS

Angle grinders, cordless drill sets, saws and sanders..

STARTERS/CHARGERS

All sizes for car and commercial use.

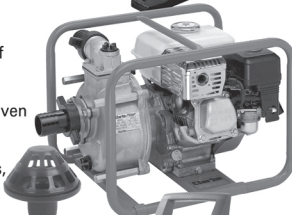

For spare parts and servicing, please contact your nearest dealer, or Clarke International on

020 8988 7400

e-mail: Parts@clarkeinternational.com e-mail: Service@clarkeinternational.com

Clarke INTERNATIONAL
Hemnal Street, Epping, Essex CM16 4LG